

MAGICVIU
Visual Marketing & Events Technology

**TECHNOLOGY
FOR RECREATION &
THEME PARKS**



MAGICVIU

MAGICVIU designs, engineers & supplies out of the box visual marketing & entertainment technologies for recreation & theme parks sold through authorized distributors worldwide.

With the increase in competition and the multiplicity of choices for customers, It has become imperative to think of high, modern and unconventional technologies to contribute to building & designing spectacular recreational parks. **MAGICVIU** has all the technologies you need as well as the ability to develop immersive content that will make these parks the talk of the hour.



Profile



Video

OUR FOCUS

INDOOR
Permenant Installation
Technology

OUTDOOR
Permenant Installation
Technology

EVENTS

HOLOGRAM DISPLAYS

01

INTERACTIVE PLAY GAMES

02

LED DISPLAYS

03

LCD SIGNAGE & DISPLAYS

04

AUGMENTED & MIXED REALITY

05

3D PROJECTION MAPPING

06

TECHNOLOGIES



01

HOLOGRAM DISPLAYS

HOLOGRAM PROJECTION GAUZE

ONSTAGE HOLOGRAM

Spectacular 3D hologram projections are created easier than ever using the ultra-lightweight and innovative projection gauze. Highly transparent and extra-wide metallic scrim for large scale 3D hologram effects. Looks so real that 3D objects appear to float in mid-air or surround a performer on stage. Projection gauze is extremely lightweight and foldable and therefore very easy to transport. It's the perfect holographic projection screen material and can be set up in no time.



Video



Catalogue



Gauze Truss Installation

Rear Projection

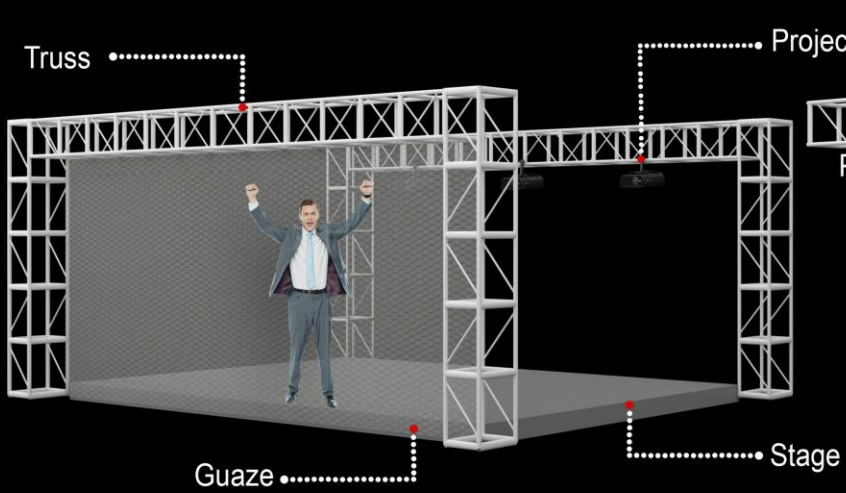

Front Projection

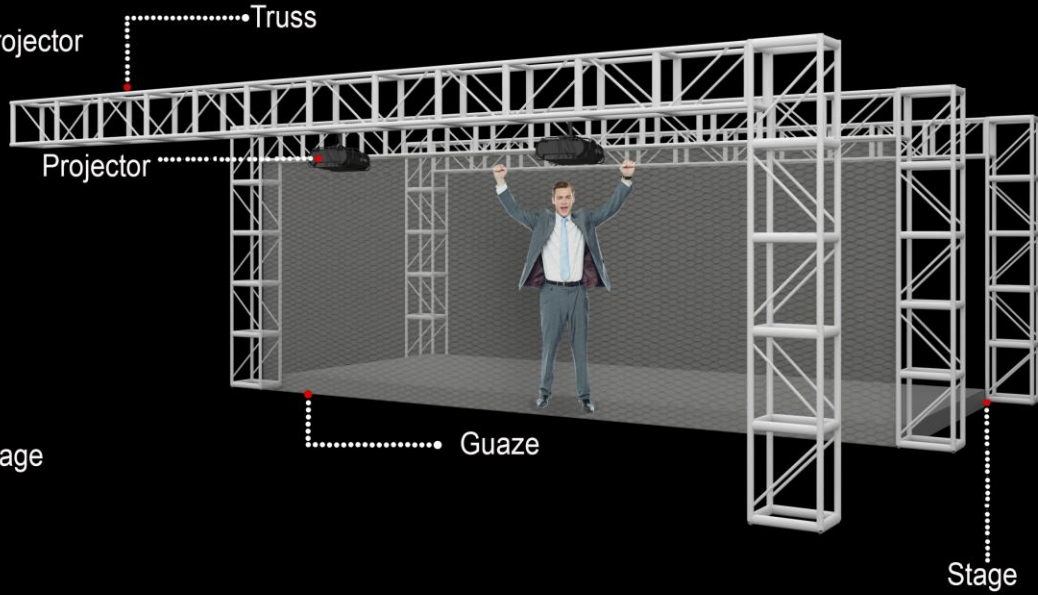



CREATING THE DIFFERENCE

Your audience will be captivated as the video and graphics float in mid air. They experience the 3D illusion without the need for glasses or headsets.

Our production team creates an immersive content for unforgettable events .

A PROJECTION SCREEN MADE OF WATER CAN HELP CREATE INCREDIBLE ILLUSIONS AND EFFECTS!



HOLOGRAM WATER SCREEN



Water screens can be used for a variety of media including Video, Lighting and Lasers. The water screen's unexpected and instant appearance in the middle of a body of water can both surprise and enchant an audience. Images appear to float in the air and are often described by members of the audience as 'holograms'.

We can deliver custom solutions to suit your requirements; systems could be fixed or floating, land based, in a lake, a pool or the sea.

There are different types of water screen available:

HYDRO SCREEN. The hydro screen creates a semi circular spray of water suitable for rear projection with lighting, laser and video. The Hydro Water Screen is created by two borehole pumps driving into a single nozzle

JET SCREEN. The unique Jet Screen consists of trident jet screen modules which can be used to create any width of screen. The Jet Screen gives much greater wind stability than a hydro screen, and is suitable for video, lighting and laser projection.

Video

A child in a plaid shirt with "SPACE LOVE PLANE" on the back is walking on a dark floor covered in colorful, glowing floral patterns. Other people are visible in the background, some standing and some on a bicycle. The scene is dimly lit, with the primary light source being the floor projection.

02

**INTERACTIVE
PLAY GAMES**

INTERACTIVE KIDS LEARNING & PLAY GAMES

MAGICVIU supplies innovative interactive play platform with endless possibilities! A technology to create Interactive Wall and Floor surfaces with projectors or any other display technology. We offer consultation, design and installation services anywhere in the world after contracting. Transform your business into a destination that children and families want to visit with solutions built by experts in interactive technology

SPORT GAMES



MINI FOOTBALL CHAMPIONSHIP



-  Video 1
-  Video 2
-  Video 3
-  Catalogue

Complete project design and installation anywhere

PROJECT REFERENCES

- ▶ Future Kids Park in MAKKAH, Saudi Arabia
- ▶ LAMBEE Park, Riyadh, Saudi Arabia
- ▶ VELOCITY Park, Dubai, U.A.E
- ▶ FUNBOX Park, Sharjah, U.A.E
- ▶ TEKZONE Park, Kuwait, Kuwait.
- ▶ Future Kids Park, Kuwait, Kuwait
- ▶ Magic Lnd Train, Manamah, Bahrain

MULTI BALL



INTERACTIVE GAMING



Make Any Wall An Interactive Gaming Area



Breathtaking Gameplay

Real Gaming - Real Sports

MultiBall is an interactive sports and gaming system combines digital games with real sports.

More than 25 applications were developed a part for **MultiBall**, which offer a variety of effective gaming and training experiences, through visual and auditory elements, different levels of difficulty and easy-to-understand gameplay.



Watch Video

MultiBall consists of a sensor frame and a console including camera system that is able to track and process all types of ball detections and player movements in real time.

The system responds to balls hitting the wall during play, or player's movement in close proximity to the wall. This ensures the physical interaction of the player with the digitized games.

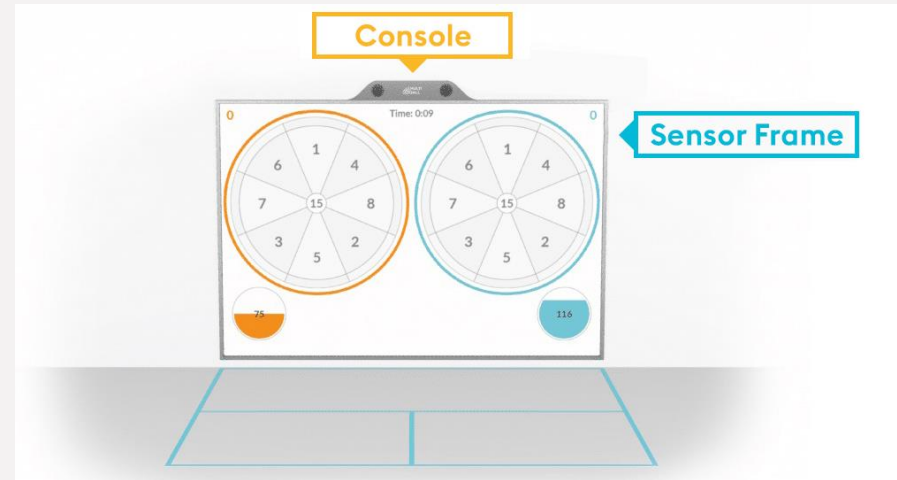

Interactive Running Track



OnTrak Realtime Location System

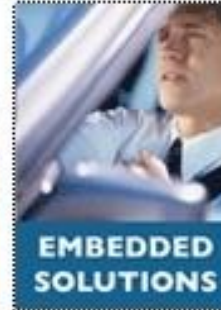

 **ontrak** Interactive running track

OnTrak Interactive running track – Introduction

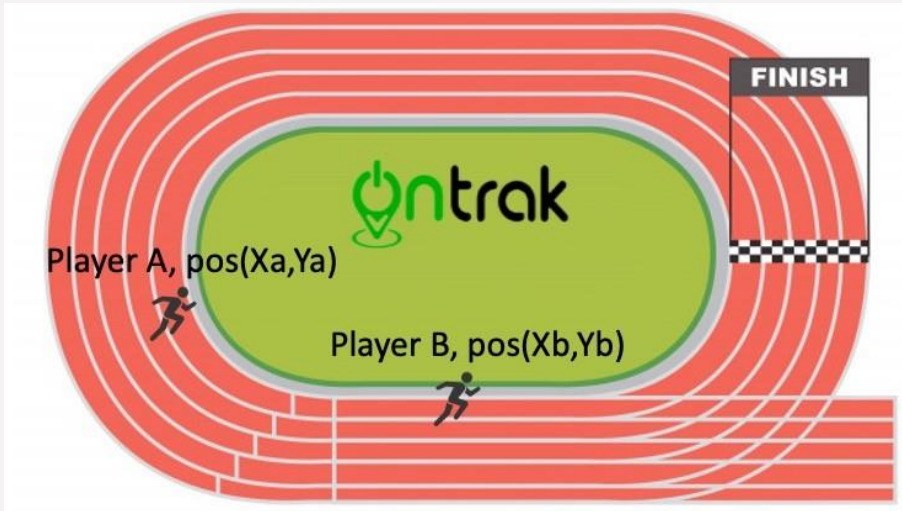

The OnTrak system provides the accuracy position (upto 10cm), speed and movement of the specific player (wearing the smart bracelet) in the running track to display avatar and movement of that player on the LED screen at the equivalent position in the real-time.

Hitech for serving human life!



Video

OnTrak Interactive running track – Introduction

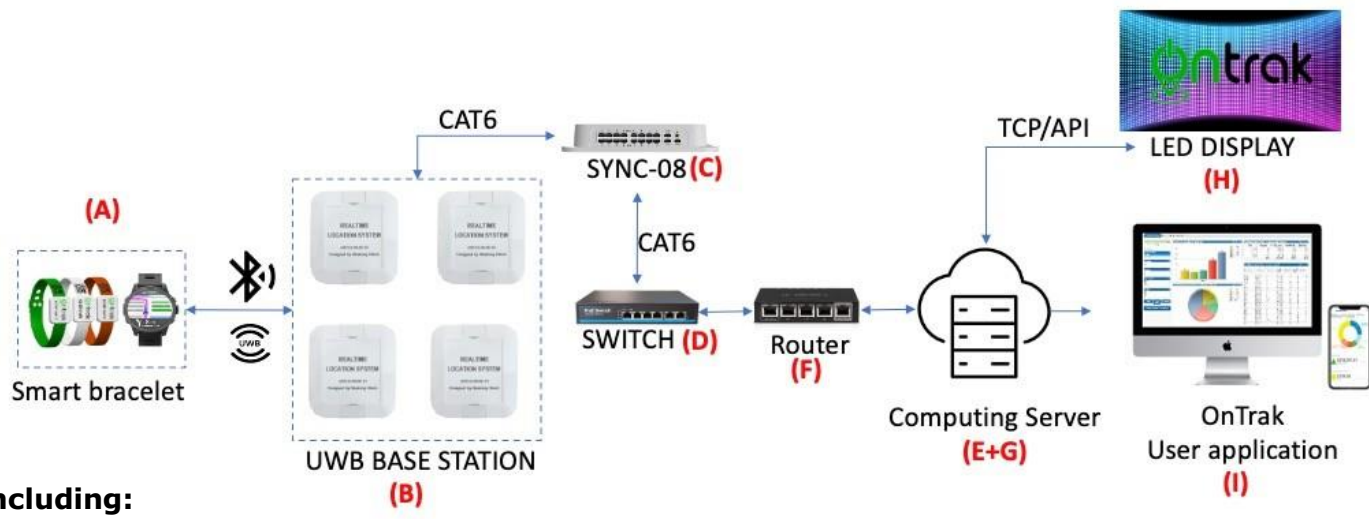

System including:

- (1) Smart bracelet for the participant (A)
- (2) Base station cover the playground (B+C)
Milo (14mx18m) – Happy Ekiden MB Ageas Life (4x25m) or any size
- (3) Ethernet network (D+F)
- (4) Server to run the OnTrak and (5) Server to run the LED display program (E+G)
- (6) Software in the computer to input the ID of the participant (to display her/his name and avatar during the running) (I)



ANIMALS TREES PARK



03

LED DISPLAYS



TYPES OF LED SCREEN

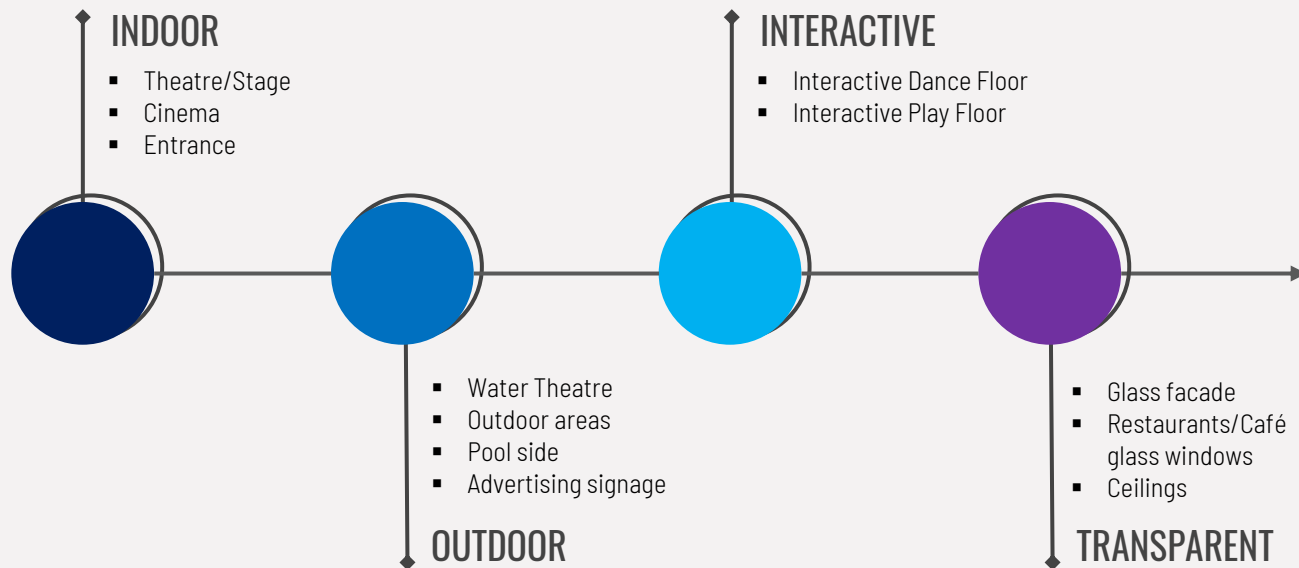

MAGICVIU supplies a large variety of LED displays that can help create nearly any size and shape screen your desire. Our LED display systems are seamless, providing clear and detailed imaging. We have a large range of creative solutions ranging from indoor, outdoor, for rental, interactive floor, stadiums, posters and curved LED screen configurations. Our high-resolution products, ability to create customized LED screens help us stand out from the rest. Whether you are looking to increase curb appeal, target impulse buyers or simply attract attention, our LED quality at affordable prices is the answer



Video



Video 2



Catalogue

INDOOR LED



MAGICVIU



MAGICVIU

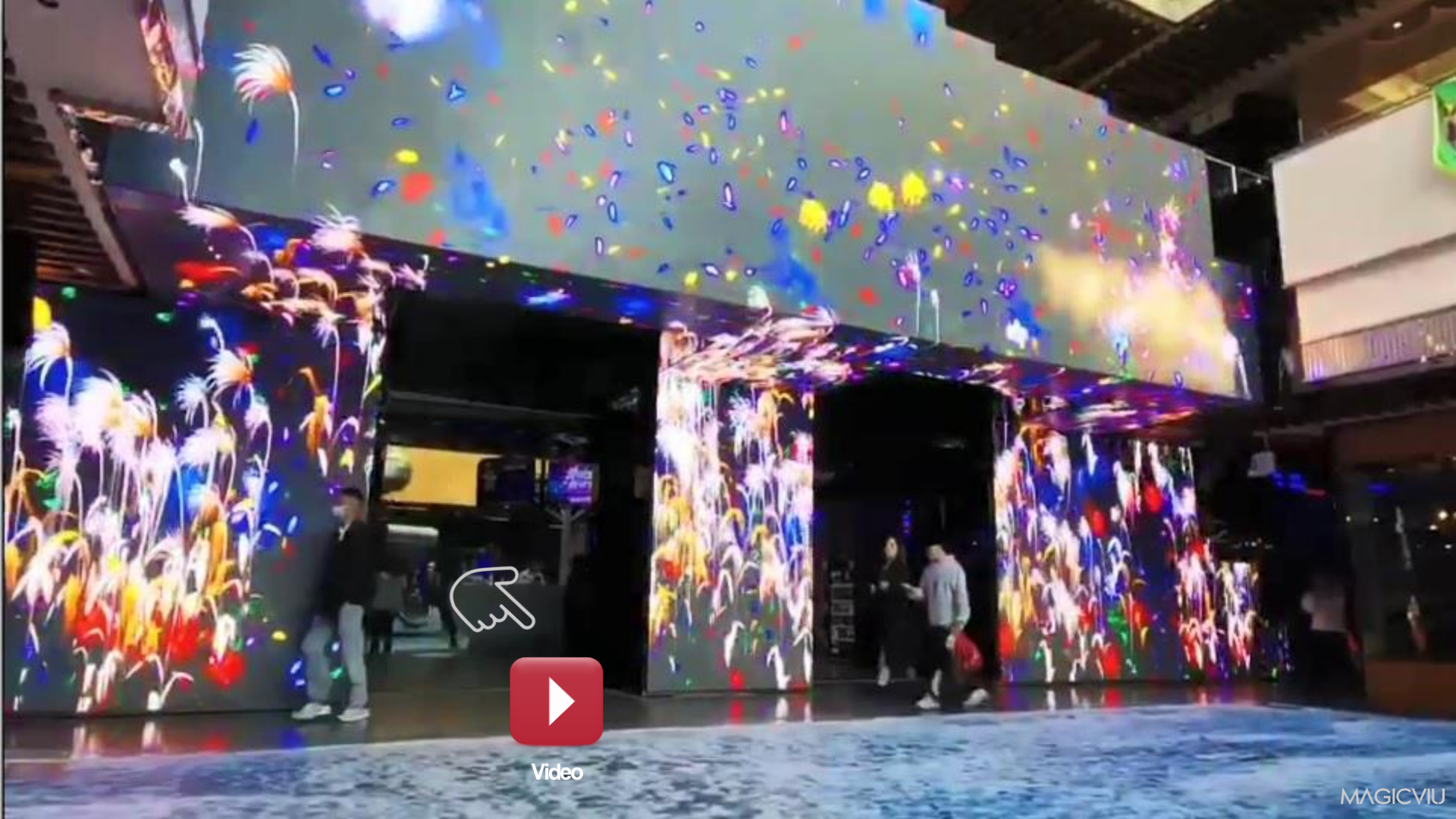

Video



OUTDOOR LED



Catalogue

INTERACTIVE Dance LED FLOOR

Interactive floor display is the ideal choice for dance floor or brands, sellers to interact with customers. Among all the similar products, **I series** stands out with its unique competitive advantages. Extremely short response times, high stability and wide viewing angles enable I series to offer customers a truly amazing experience. With the load capacity exceeding 2000kg/sqm, with excellent load-bearing performance.



Video 1



Video 2
Load Test



Catalogue



Transparent LED Screens

Where to use

In-Store

**Store's glass window
indoor or outdoor**

**Structure glass façade &
Panoramic elevator**



Video Catalogue

Transparent LED Screen is a type of LED display screen that is clear like a glass (60%-85% transparency) and has functions of an LED. It enables the viewers to see whatever is shown on the glass along with providing a complete coverage of its background as well. Since it enables audience to see what is happening behind the screen, it is also referred to as a see-through screen.

Transparent
Screen for
glass facade

LED
structure



Transparent LED
Screen for ceiling

04

LCD SIGNAGE & DISPLAYS

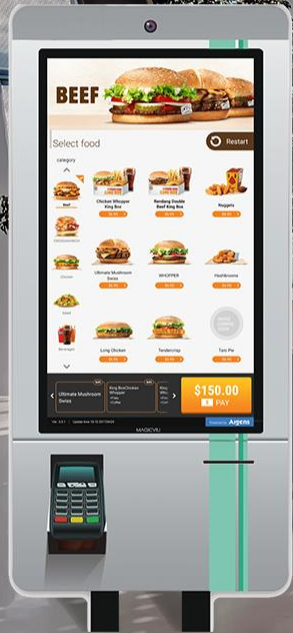

DIGITAL DIGNAGE WITH ENDLESS CHOICES



MAGICVIU digital signage encompass a wide range of solutions from video wall mounts, LCD screens or interactive kiosks to outdoor displays. Whether you need digital signage for advertising, information or entertainment, our sleek look and high-quality products at affordable prices will transform your environment with the right message at the right time



Catalogue

Multitouch Solutions

Engage Your Audience



Hardware & Software

Promultis multitouch solutions, bespoke interactive experience with limitless possibilities. High brightness, durable quality indoor and outdoor products for various business and advertising applications. The Promultis ultimate Suite with over 42 apps including presentation, creativity and productivity tools, as well as games and puzzles. Check our multitouch complete solutions



Video 1



Video 2



Video 3



Catalogue

LCD Smart Mirror

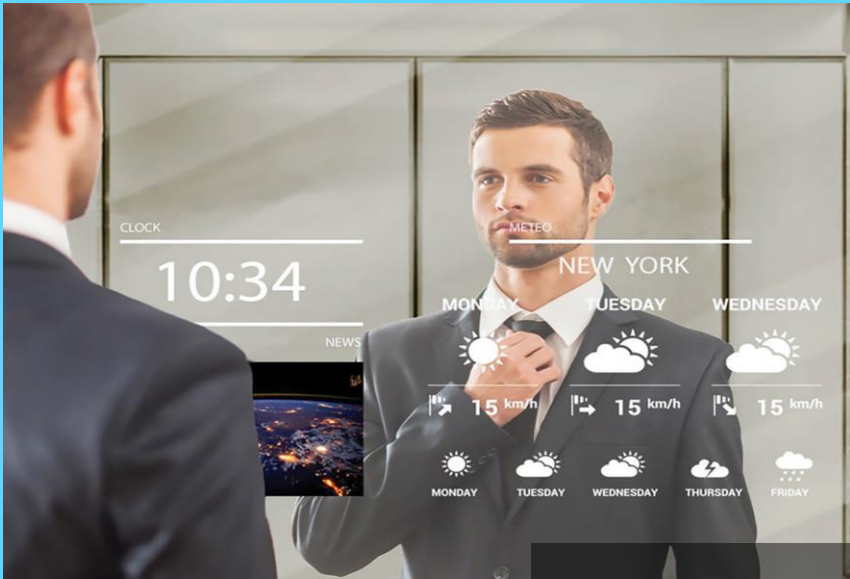
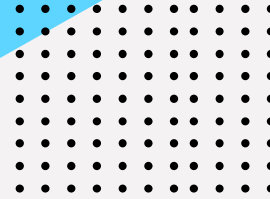

A Smart Mirror or sometimes called Magic Mirror is a two-way mirror with an inbuilt display behind the glass. The display can show anything you want on the mirror's surface such as the current time, weather forecast, news feed, upcoming appointments, and more.

Smart mirrors can come in different sizes and designs. Smart mirrors are sometimes called 'Magic' Mirrors, but they both refer to the same thing.



Catalogue Video

What Can A Smart Mirror Do?

What makes a Smart Mirror 'smart' is the ability to display any information you want on it. A smart mirror can be customized to display local weather forecasts, news bulletins, your upcoming calendar schedule, social media feeds, etc.

It's possible to even add voice commands using Amazon's Alexa or Google's Home Assistant. With voice commands you can ask your mirror questions, set reminders, or control other smart devices in your home.



SMART MIRROR PHOTOBOOTH

This digital adaptation of the mystical magic mirror brings the mystery to life and leaves your visitors/Guests in awe with excitement. Ones deployed, the touch screen magic mirror photobooth is completely self operable.

The magic mirror photo booth is quite popular for use at personal occasions such as birthday parties, weddings and even corporate events such as exhibitions, forums, tradeshow, and marketing activations.

MAGICVIU has extensive experience in providing hassle-free deployment of this magical selfie



Affordable LCD Video Wall Solutions for Every Industry



Bring the wow factor to your business and create an experience your customers will never forget. Whether you want tiled displays with multiple screens, large single unit systems or a solution in between, **MAGICVIU** has you covered with everything you need to make a lasting impression. **MAGICVIU** provides super & ultra-narrow bezels 3,5mm, 1,8mm, 0,88mm and 0,00mm bezel on request



Catalogue



05

**AUGMENTED &
MIXED REALITY**

AUGMENTED REALITY FOR ENTERTAINMENT

Augmented Reality- A technology that blurs the line between what's real and what's computer-generated by enhancing what we see and hear
MAGICVIU was born out of the same seed of thought, Visual Marketing!
“With our Augmented Reality, we have started our journey with a vision to connect people with products virtually by placing virtual products in the real world.

Using **Microsoft HoloLens 2** we can develop 3D holographic AR resulting in an unforgettable experience for your audience.



Video

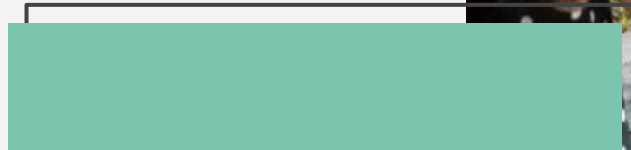

Video 1



Video 2

MAGICVIU

06

3D PROJECTION MAPPING

3D Projection mapping

By projecting beautiful imagery over complex architecture and surfaces we create immersive content for advertising, sponsorship, national day celebrations, and other special events, as well as in permanent tourism attractions. We work with reliable projectors leasing companies in different countries to provide our customers with a full package service.



Video



MAGICVIU

Hologram Displays **LCD & LED Displays** **Projection & Smart Films**
Interactive Surfaces **Virtual & Augmented Reality** **Projection Mapping**